

# 4' DIA DOUBLE CATCH BASIN

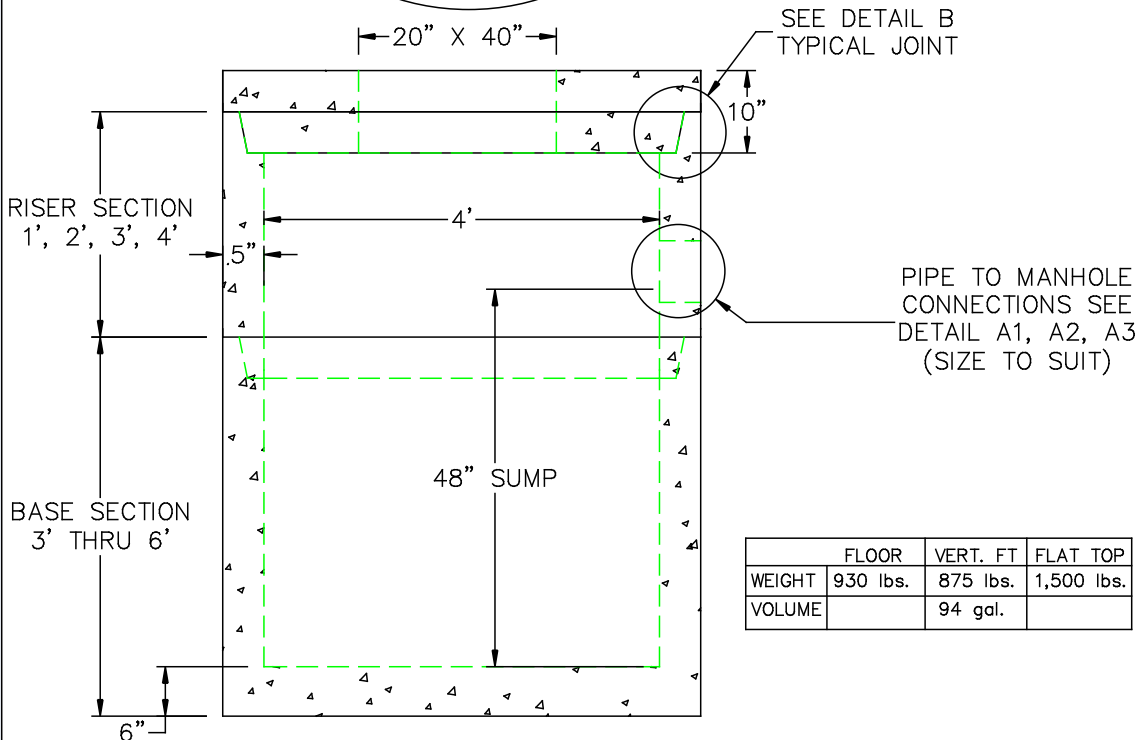
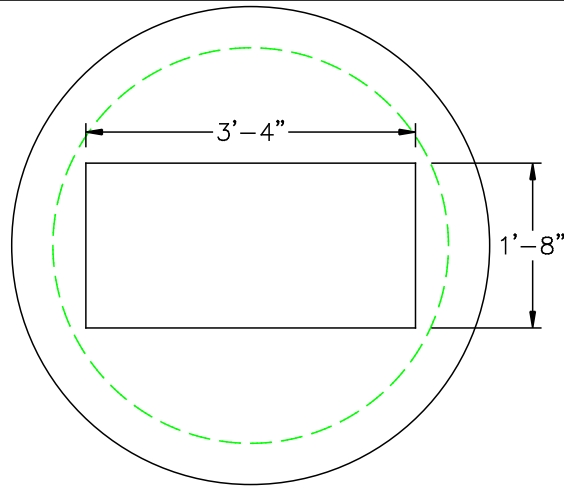

|        | FLOOR    | VERT. FT | FLAT TOP   |
|--------|----------|----------|------------|
| WEIGHT | 930 lbs. | 875 lbs. | 1,500 lbs. |
| VOLUME |          | 94 gal.  |            |

## DESIGN NOTES:

1. MANUFACTURED TO MEET OR EXCEED: ASTM C-478 & AASHTO M 199 SPECS.
2. CONCRETE = 4,000 PSI. MINIMUM CEMENT PER ASTM C-478 (6.1)
3. REINFORCED STEEL CONFORMS TO LATEST ASTM A 185 SPECIFICATIONS. 0.12 SQ. IN / LINEAL FT. AND 0.12 SQ. IN (BOTH WAYS) BASE BOTTOM
4. STEEL REINFORCEMENT TO MEET OR EXCEED AASHTO HS-20 LOADING
5. MANHOLE STEPS MEET LATEST OSHA REGULATION 29 CFR1910.27, SECTION 16 OF ASTM SPECIFICATION C478 AND SECTION 10 OF ASTM SPECIFICATION C497
6. BUTYL RUBBER JOINT SEALANT PER ASTM C-990 & ASHTO M-198

A1  
COMPRESSION GASKET (CAST IN)

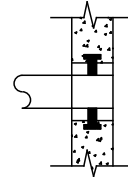

A2  
FLEXIBLE SLEEVE

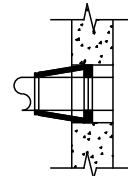

A3  
MORTAR BY CONTRACTOR

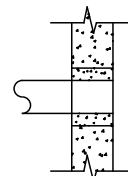

B  
BUTYL RUBBER SECTION JOINT

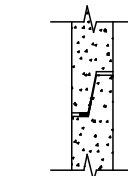

C  
POLYPROPYLENE MANHOLE STEPS

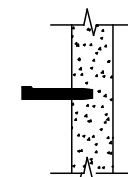

SCITUATE RAY PRECAST  
120 CLAY PIT ROAD  
MARSHFIELD, MA 02050  
PHONE # 1-800-440-0009  
FAX # 781-837-4320

CONTRACTOR:

JOB NAME:

DATE:

DRAWING: SRP-CB4

DRAWING BY: C.J. SCOTT

